

1 EXTERIOR C.M.U. WALL TYPE 1 A903 NOT TO SCALE

2 EXTERIOR C.M.U. WALL TYPE 2 A903 NOT TO SCALE

3 EXTERIOR C.M.U. WALL TYPE 3 A903 NOT TO SCALE

4 EXTERIOR C.M.U. WALL TYPE 4 A903 NOT TO SCALE

5 PARTITION TYPE 5 A903 NOT TO SCALE

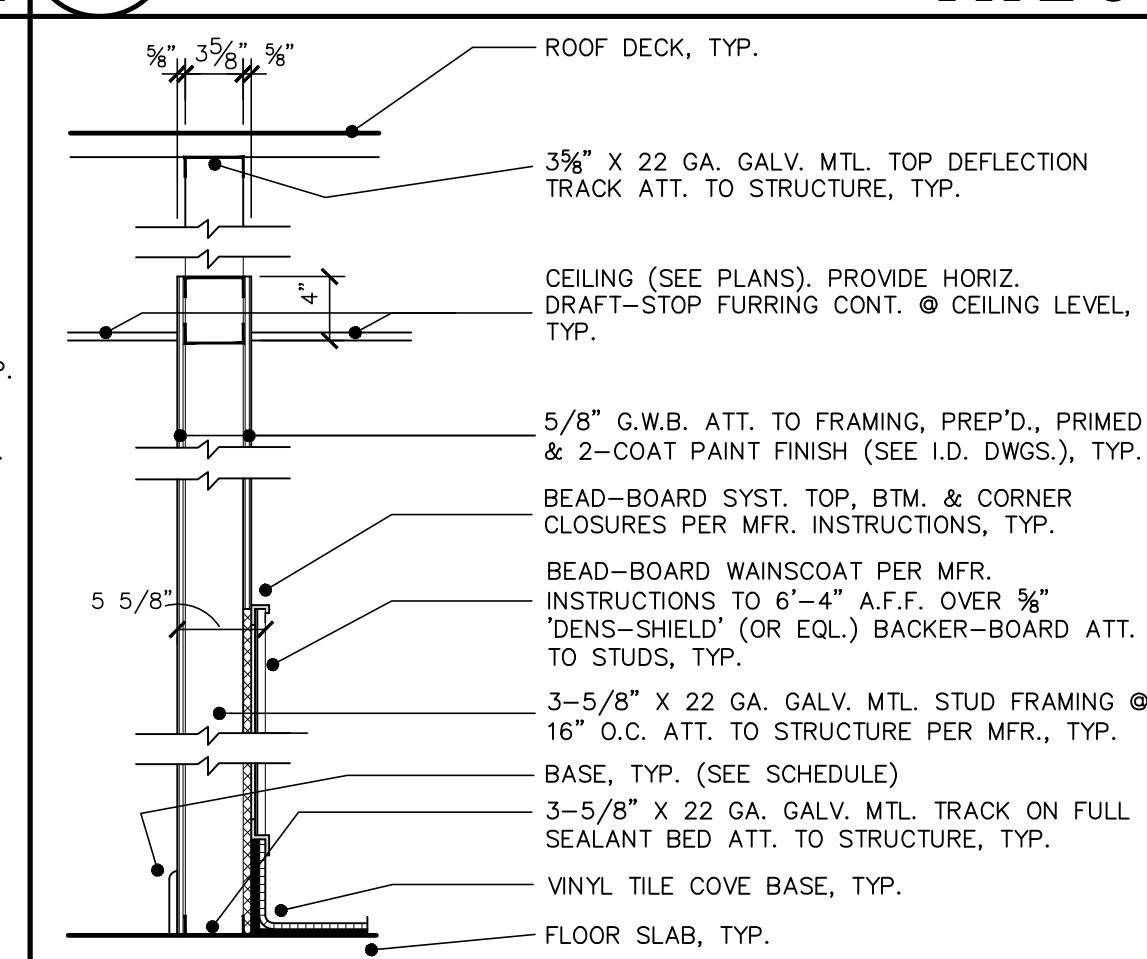
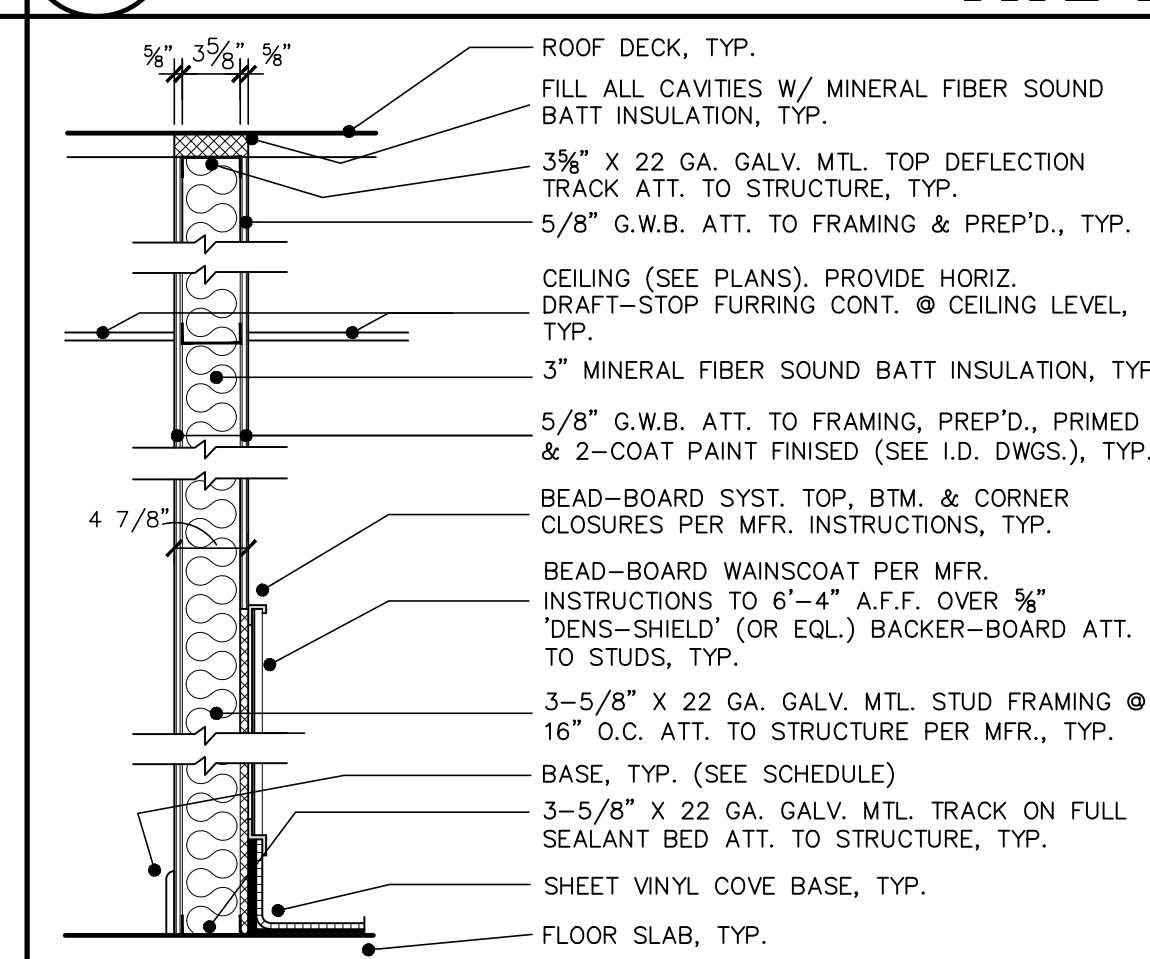
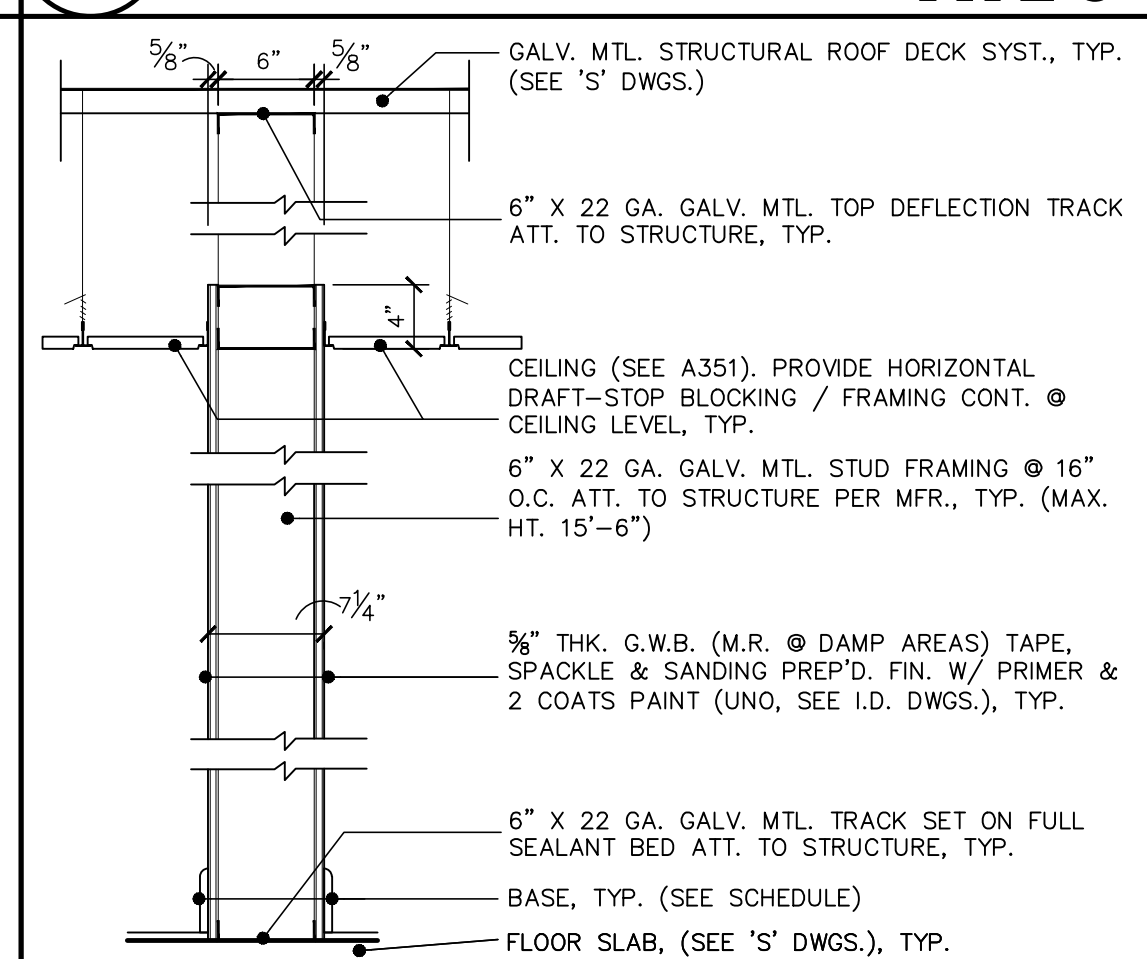
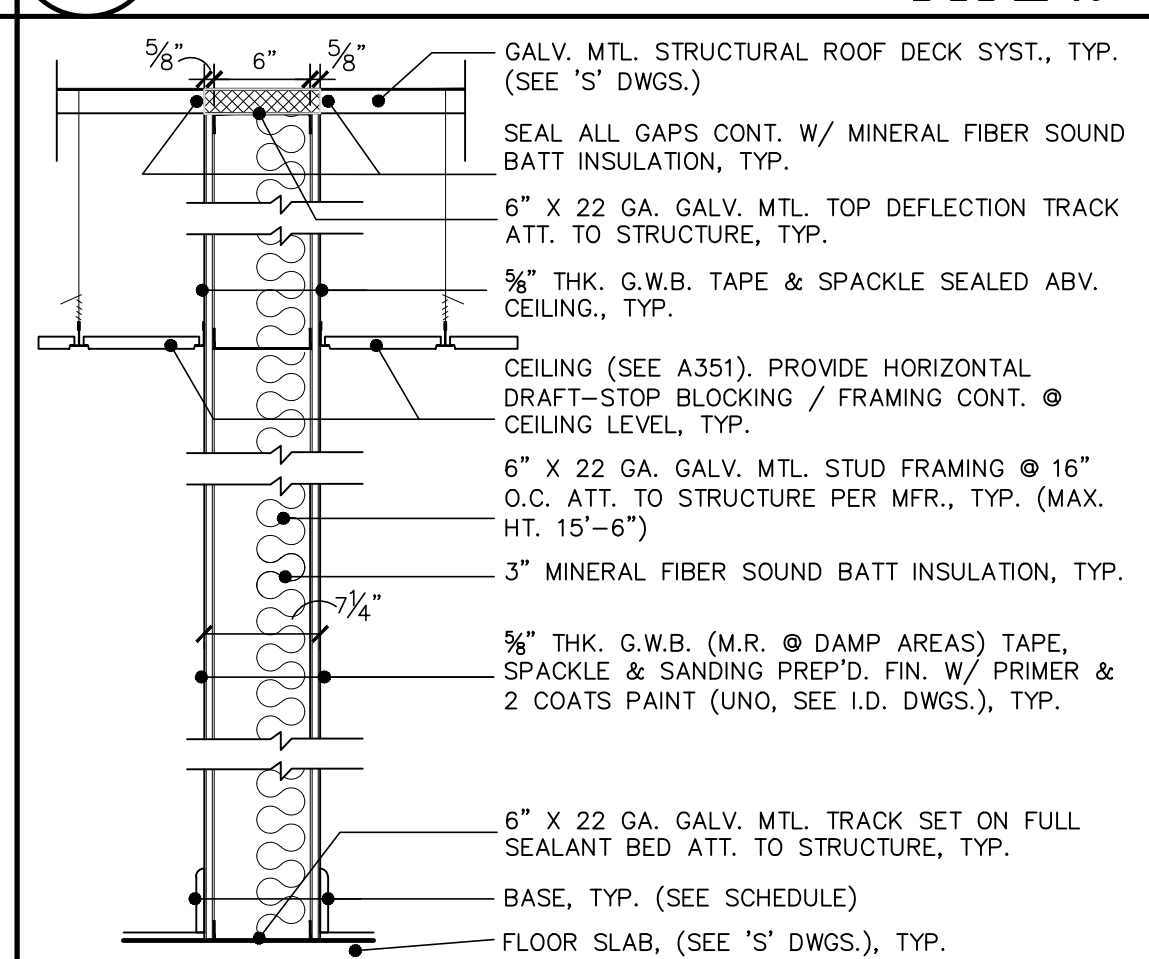
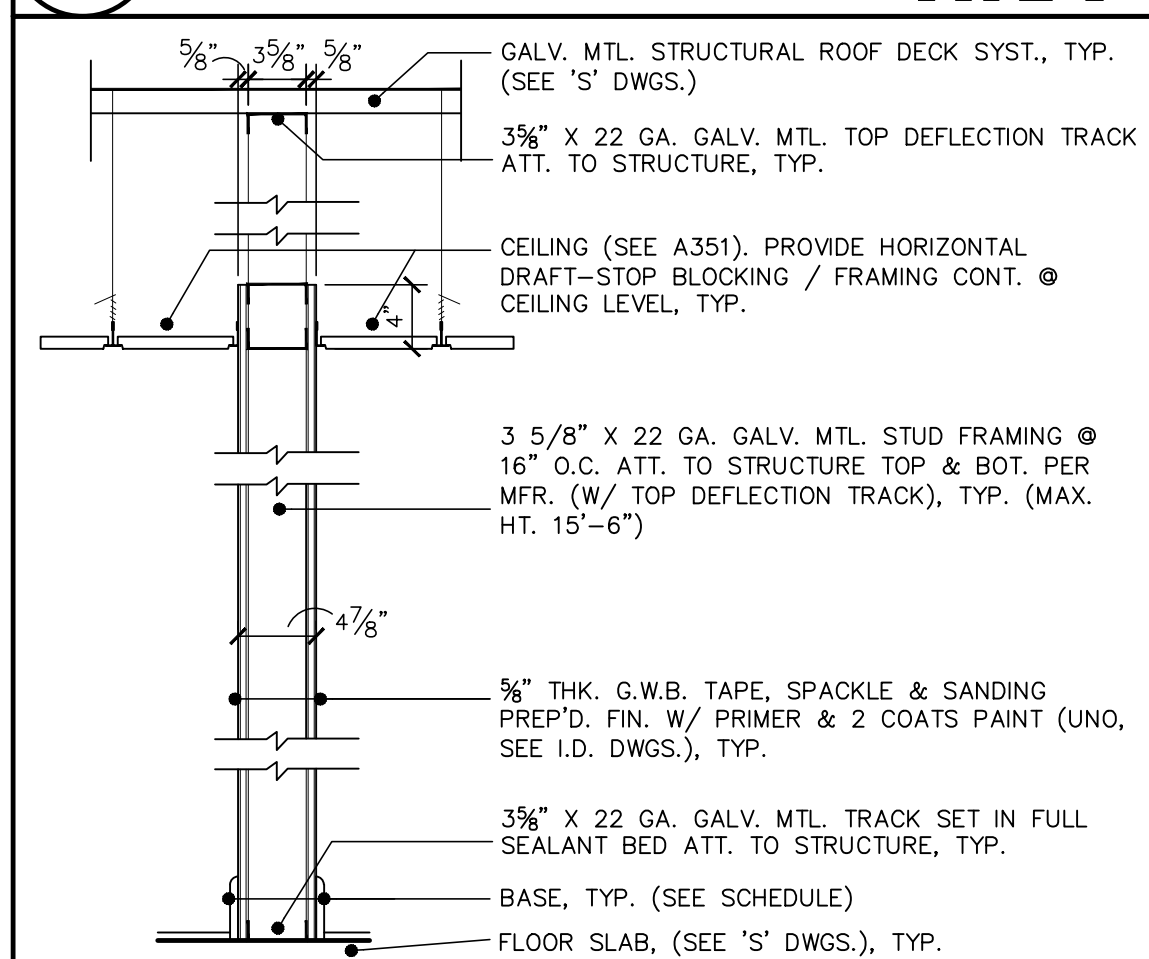

6 PARTITION TYPE 6 A903 NOT TO SCALE

7 PARTITION TYPE 7 A903 NOT TO SCALE

8 PARTITION TYPE 8 A903 NOT TO SCALE

9 PARTITION TYPE 9 A903 NOT TO SCALE

10 PARTITION TYPE 10 A903 NOT TO SCALE

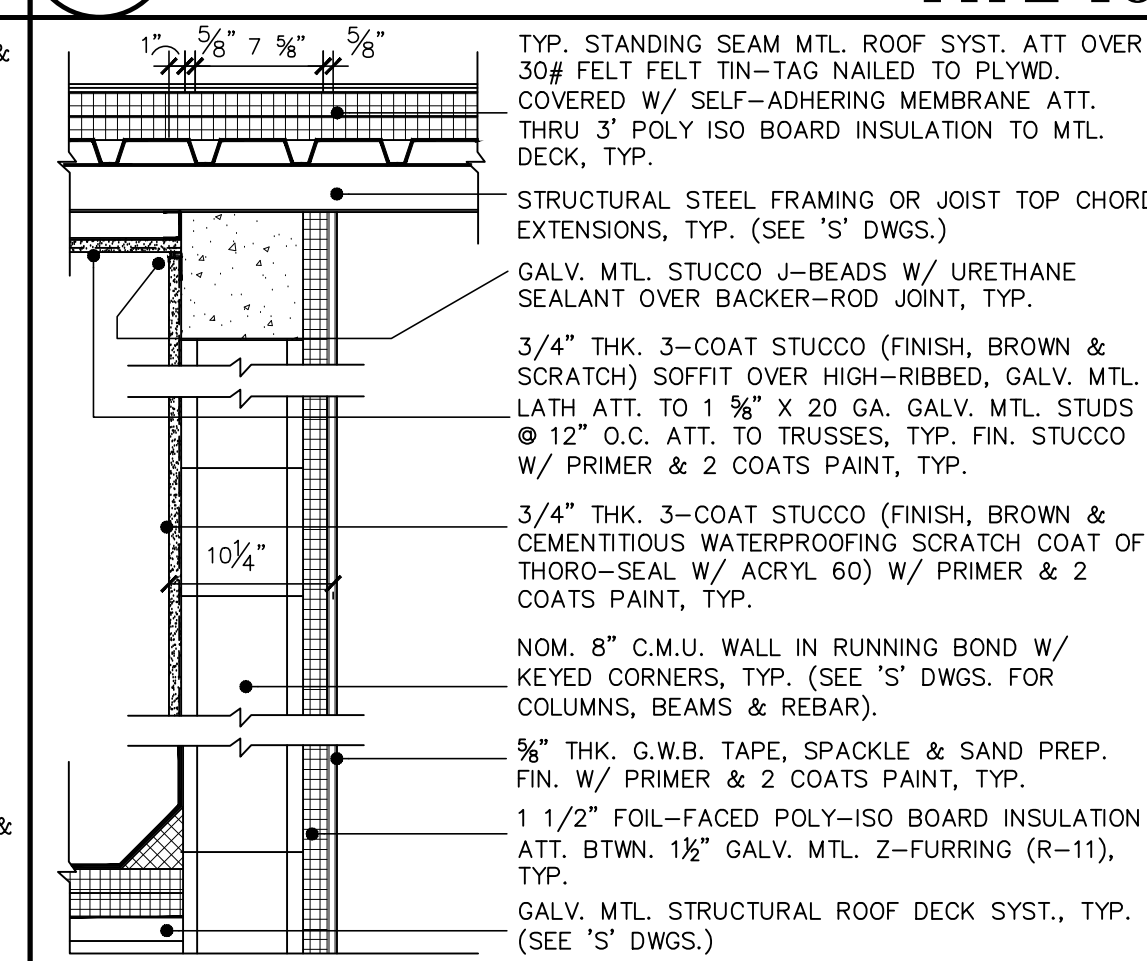
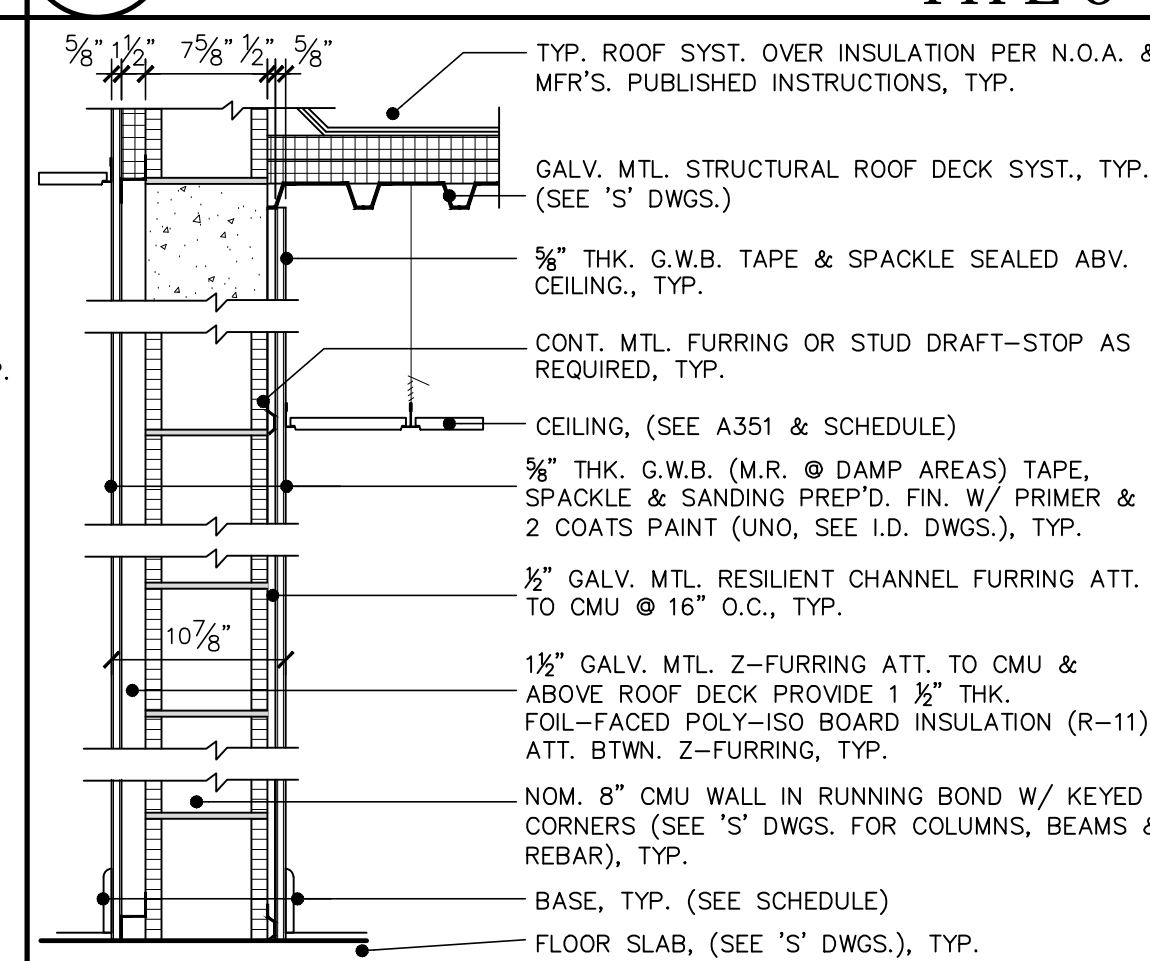
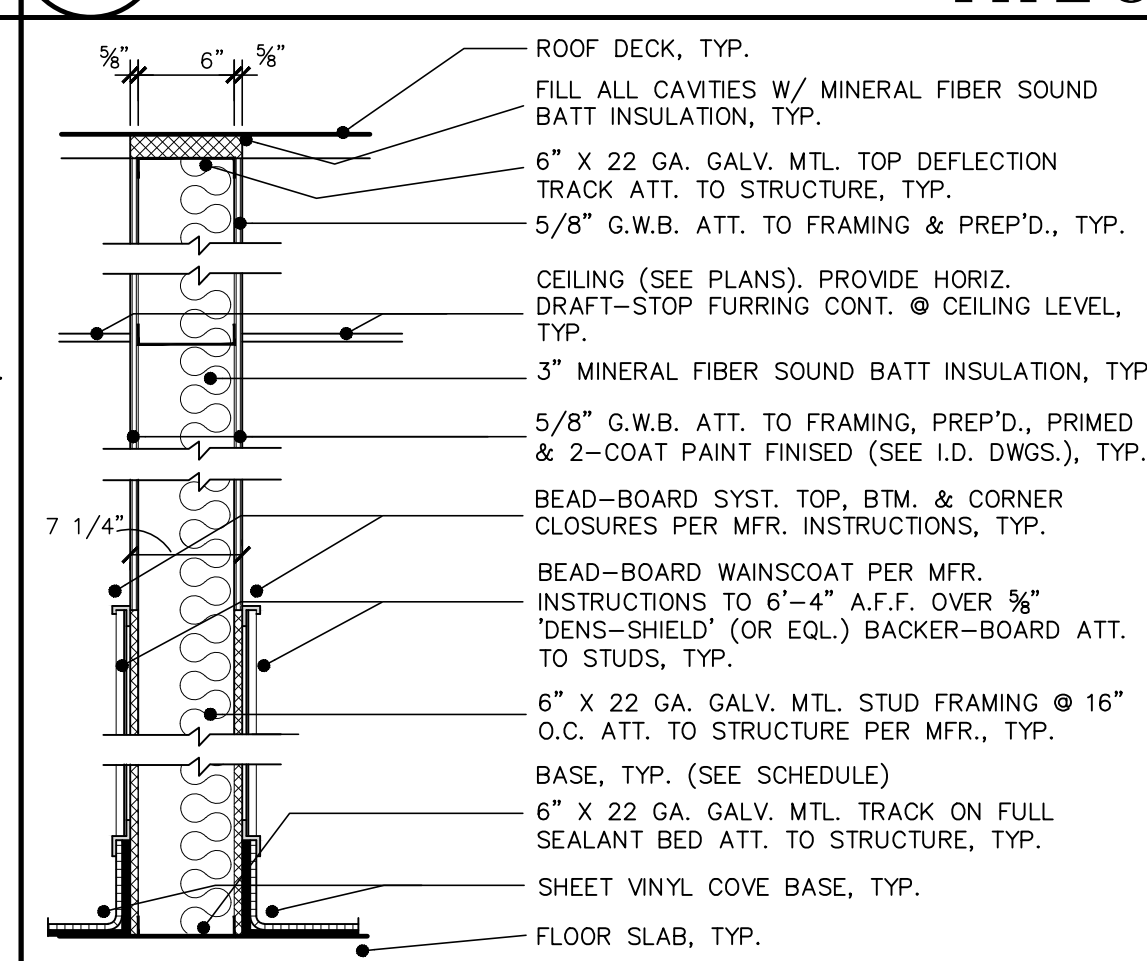
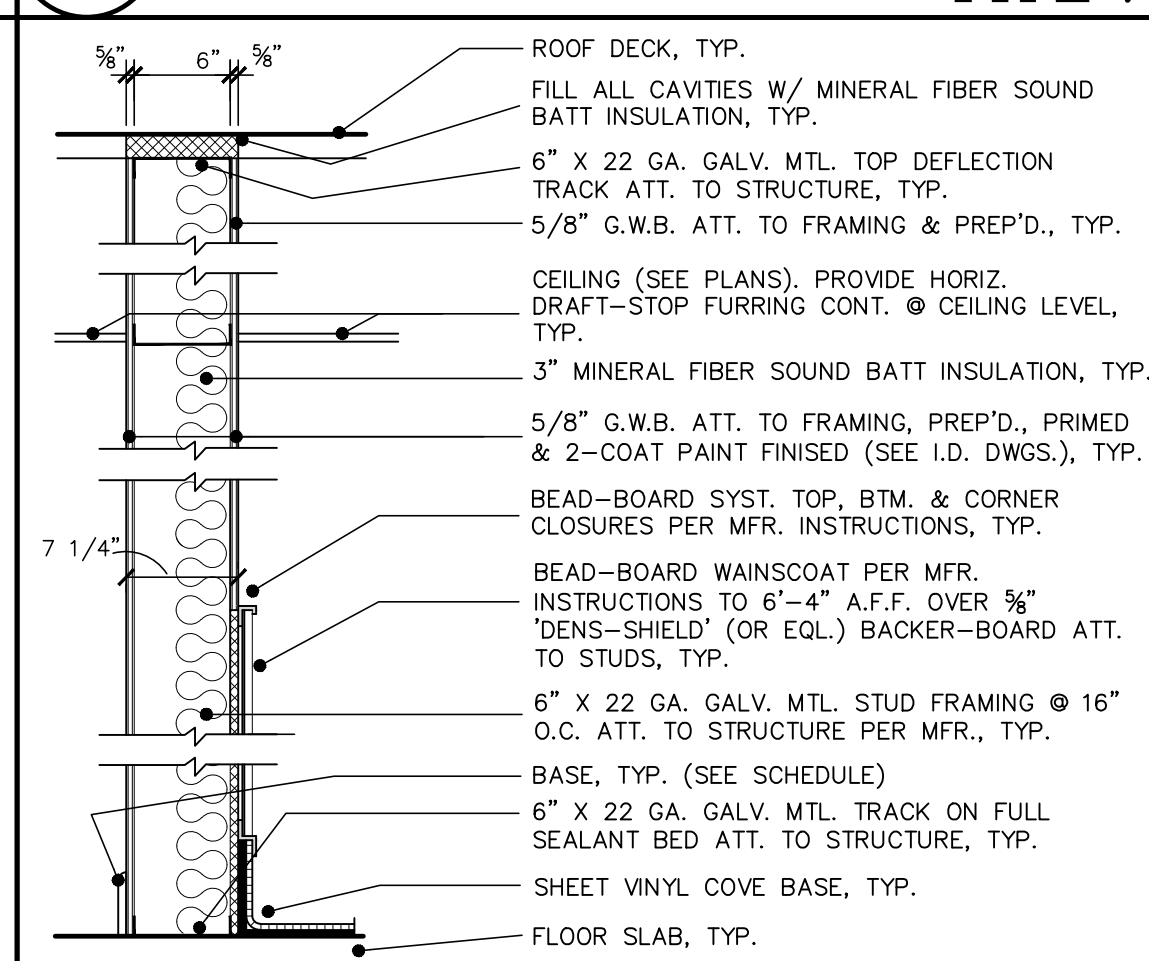
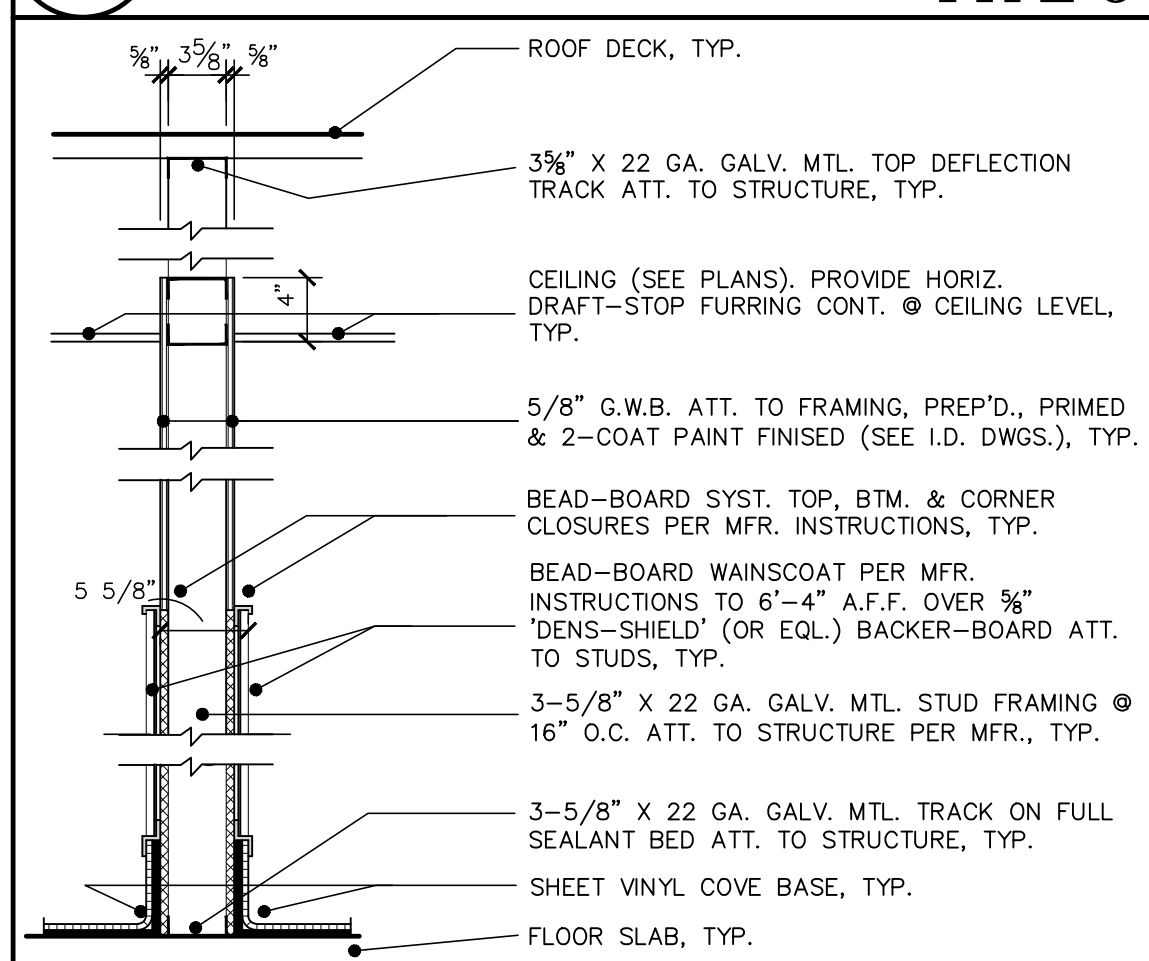

11 PARTITION TYPE 11 A903 NOT TO SCALE

12 PARTITION TYPE 12 A903 NOT TO SCALE

13 PARTITION TYPE 13 A903 NOT TO SCALE

14 INTERIOR WALL TYPE 14 A903 NOT TO SCALE

15 EXTERIOR C.M.U. WALL TYPE 15 A903 NOT TO SCALE

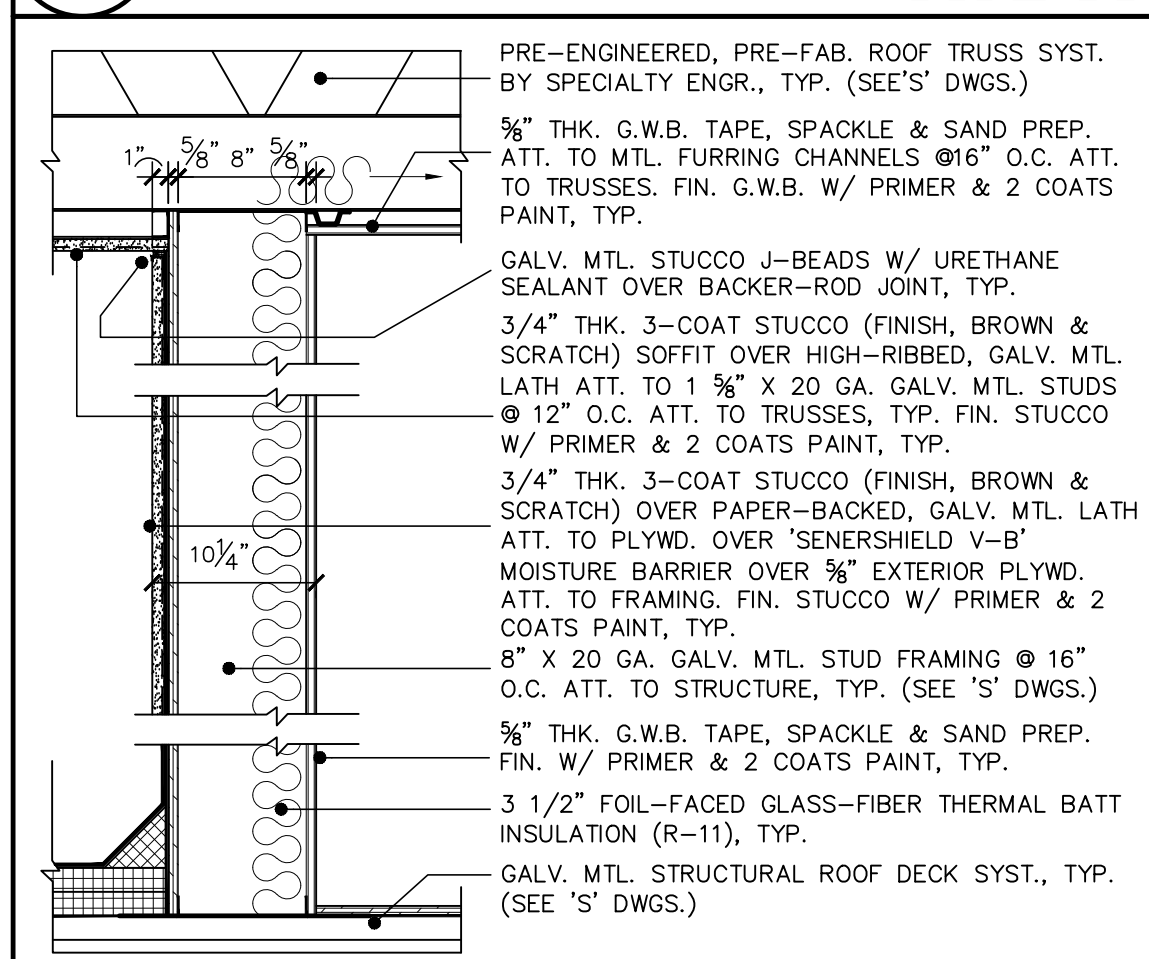

16 EXTERIOR C.M.U. WALL TYPE 16 A903 NOT TO SCALE

REVISIONS	BY

**Slattery & Associates**  
 ARCHITECTS  
 PLANNERS  
 2060 NW BOCA RATON BLVD.  
 SUITE 2  
 BOCA RATON, FL 33431  
 TEL: 561-392-3848  
 FAX: 561-392-5402  
 WWW.SLATTERYARCHITECTS.COM

ACTIVITY CENTER FOR FLORENCE FULLER CHILD DEVELOPMENT CENTERS WEST CAMPUS S.W. 185TH STREET BOCA RATON, PALM BEACH COUNTY, FLORIDA

BIDDING NOT FOR CONSTRUCTION  
 SEAL DATE: X-XX  
 SLATTERY & ASSOCIATES  
 FLORIDA REGISTRATION # AA000381

ISSUED	CR, DR, AB
CHECKED	KB
DATE	10-21-16
SCALE	AS NOTED
JOB NO.	2011-64
SHEET	

**A903**

WALL TYPES

DATE: 10-21-16